

eurotech

LUXURY SHOWER DOORS

MONACO

TWINGLIDE FRAMELESS DUAL SLIDING SHOWER DOOR



Eurotech Showers

23532 Commerce Center Dr
Building B
Laguna Hills, CA 92653
949-716-4099
eurotechshowers.com

SUPER EASY INSTALL



eurotech
LUXURY SHOWER DOORS



HARDWARE FITS UP TO 60" WIDE OPENING

Tools Required

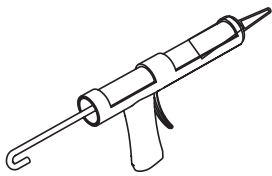

Silicone

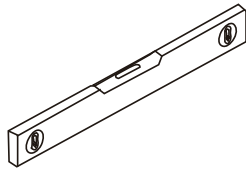

Level

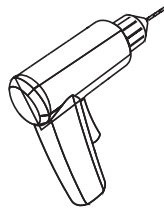

Drill

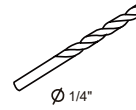

Masonry Bit

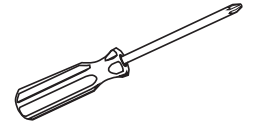

Screwdriver
(Phillips)

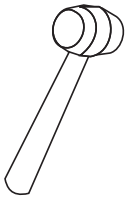

Mallet



Pencil

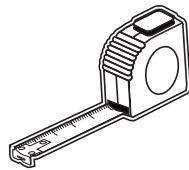

Tape Measurer

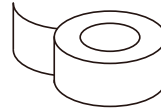

Painters
Tape

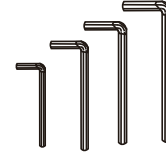

Allen Wrenches
(included)

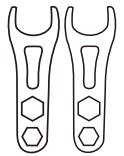

Wrenches
(included)



This product is heavy and may require two people to install.



Congratulations on your purchase of your Eurotech Shower door, making your shower dreams come to life.

◆ Assembly Drawing

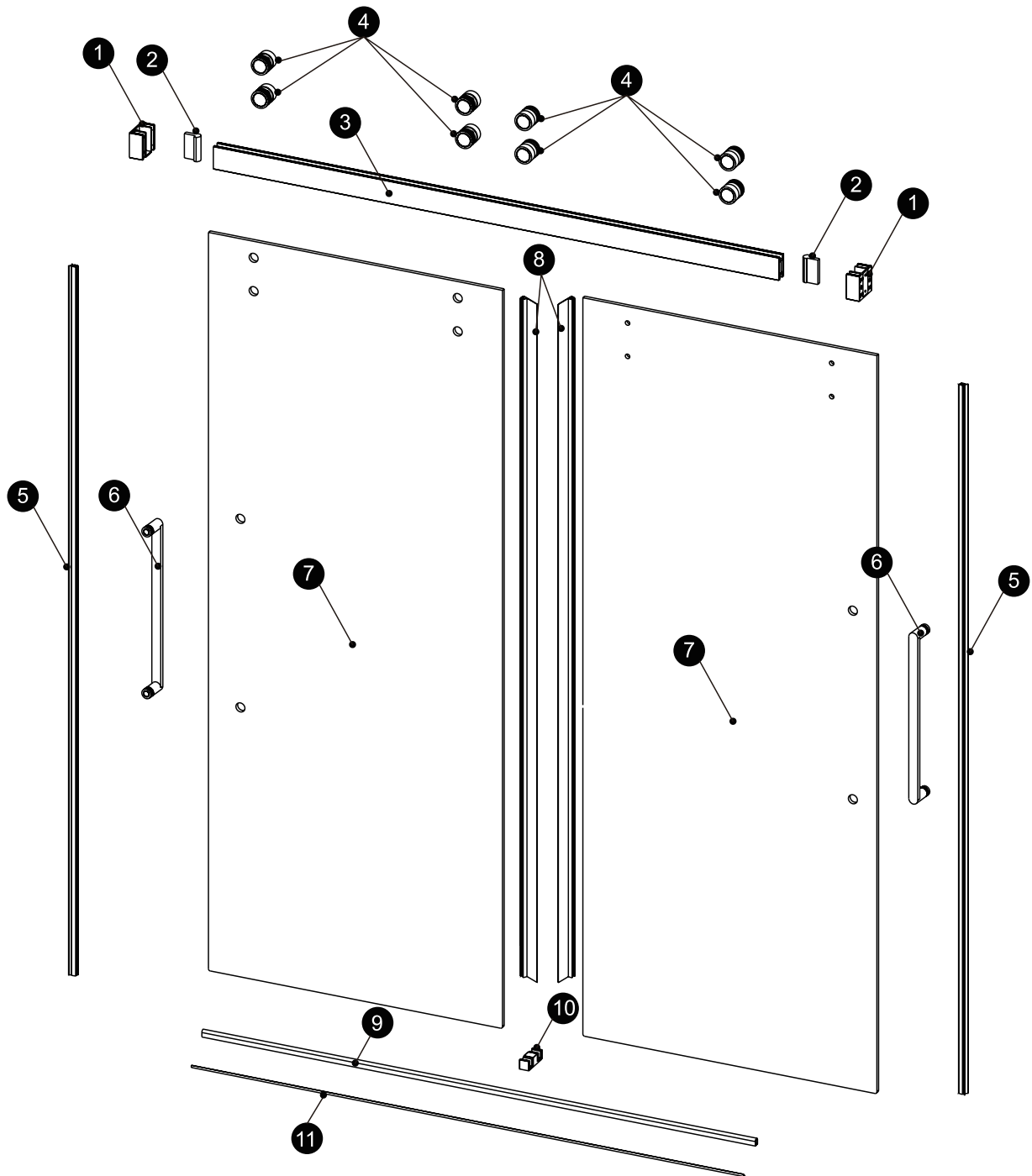

PACKING LIST

PART #	DESCRIPTION	Q'TY	PART #	DESCRIPTION	Q'TY
1	Wall Bracket	2pcs	7	Door Panel	2pcs
2	Safety Bumper	2pcs	8	F Seal	1pc
3	Track	1pc	9	Aluminium Water Guard	1pc
4	Roller	8pcs	10	Glass Guide	1pc
5	V Seal	2pcs	11	L Seal	1pc
6	Handle	2pcs			

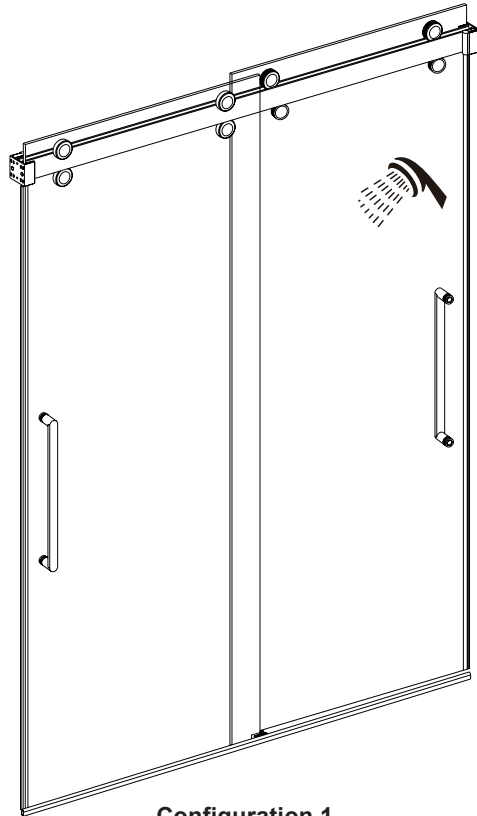

Configuration 1

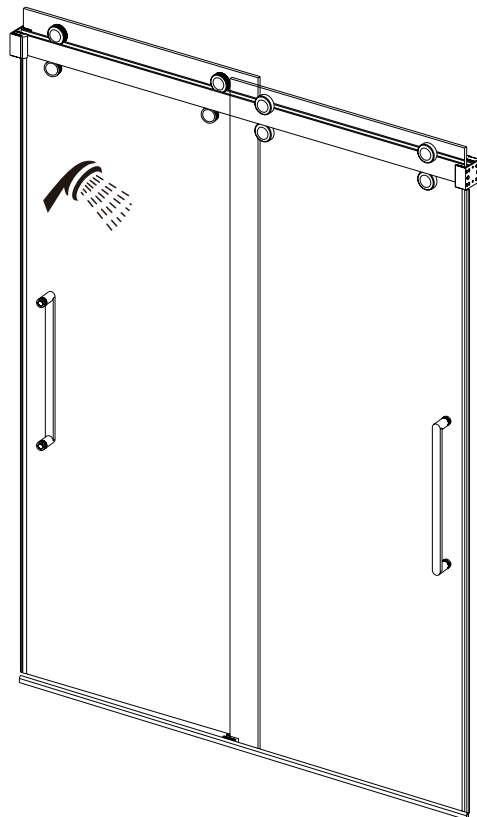

Configuration 2



(This Configurations is illustrated in this Manual)

Bar Installation: Mount wall bracket on **high side** first.
Level bar to mark opposite wall for second wall bracket.

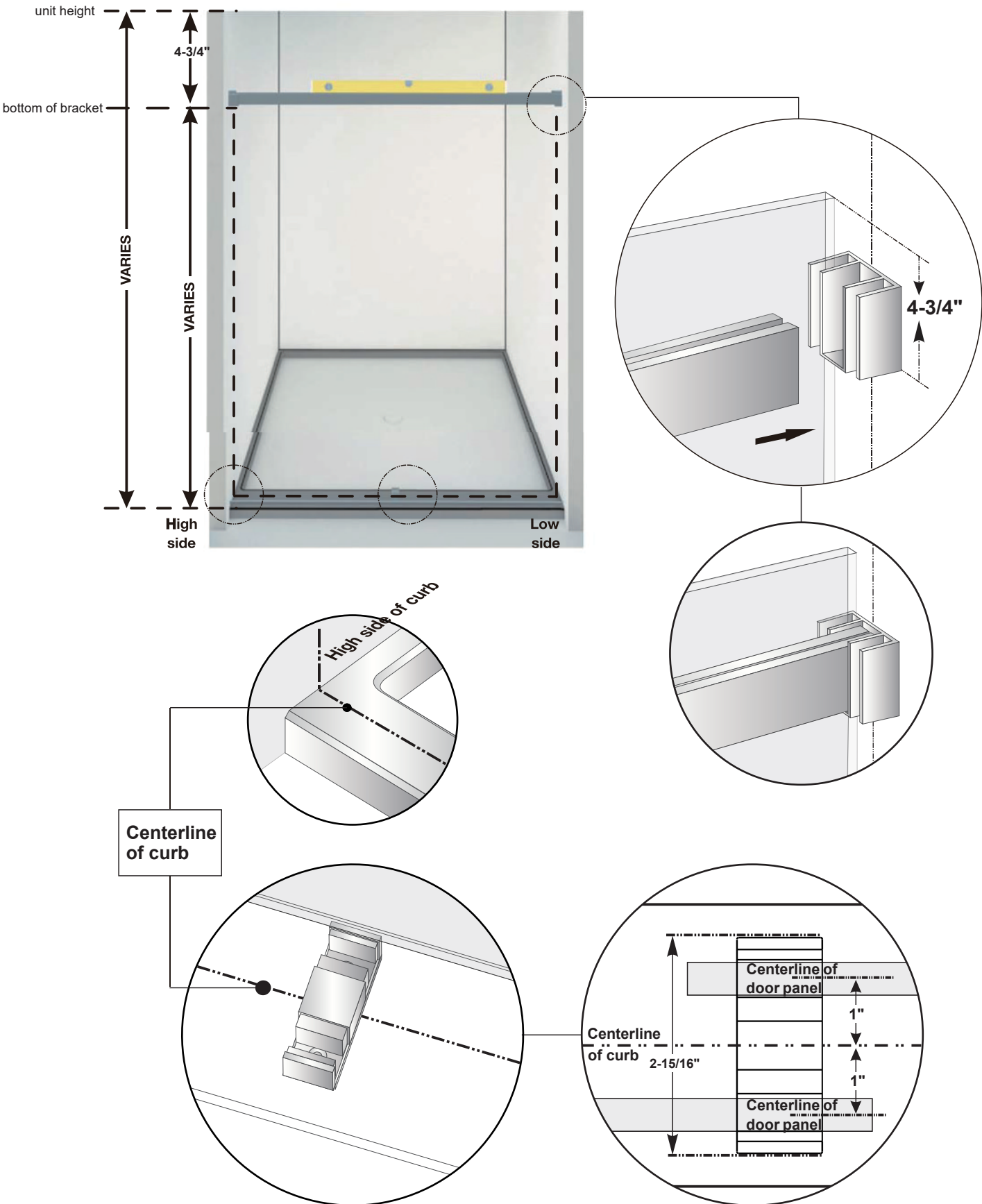

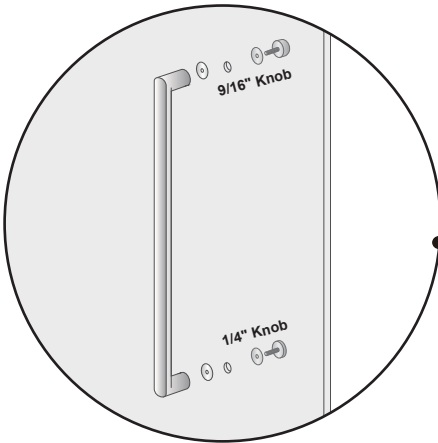
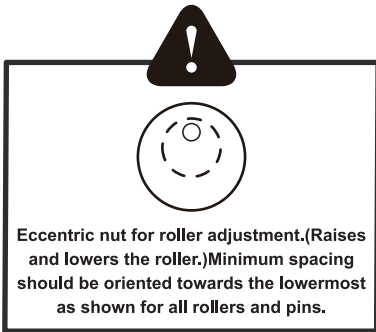
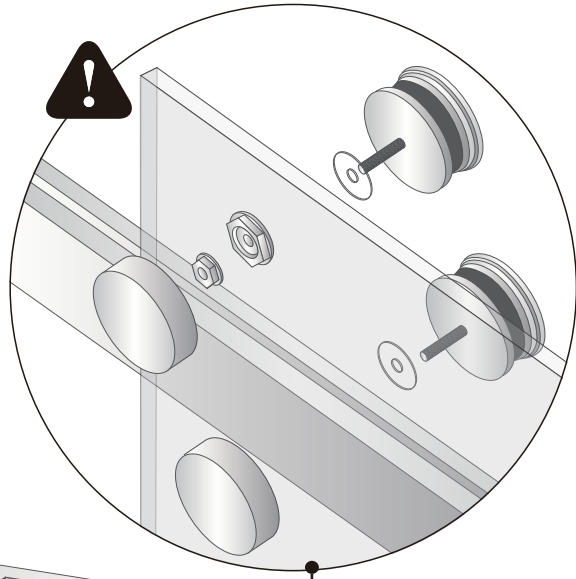
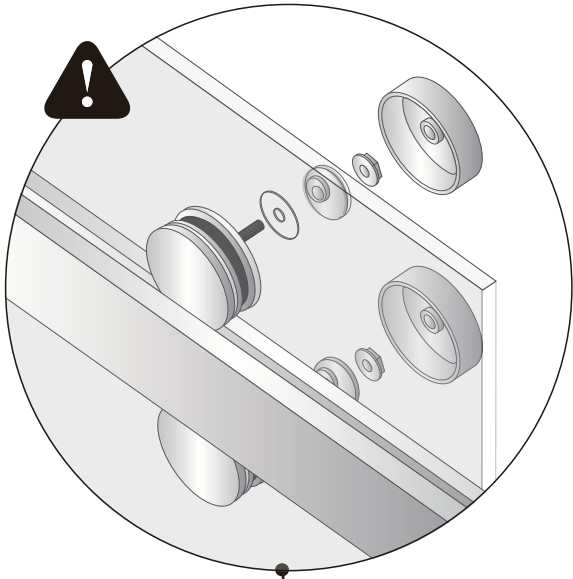

◆ Safety Bumper Page

For configurations with shower head to the left insert safety bumpers into wall brackets as shown

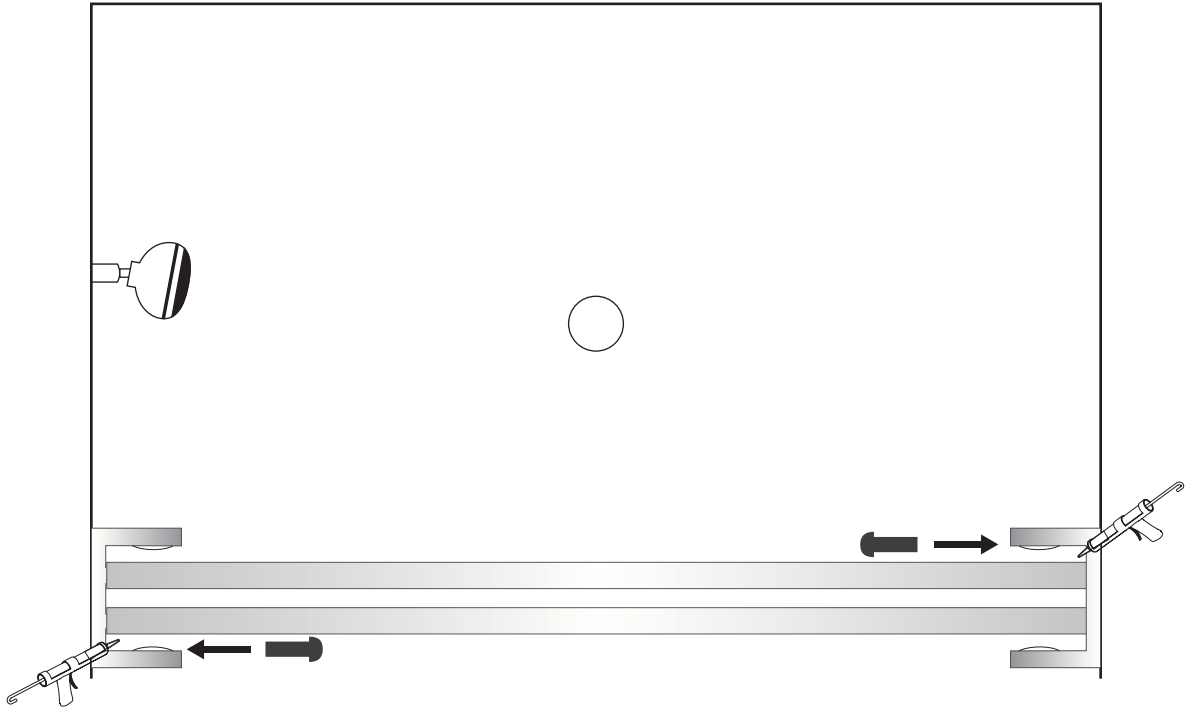

For configurations with shower head to the right insert safety bumpers into wall brackets as shown

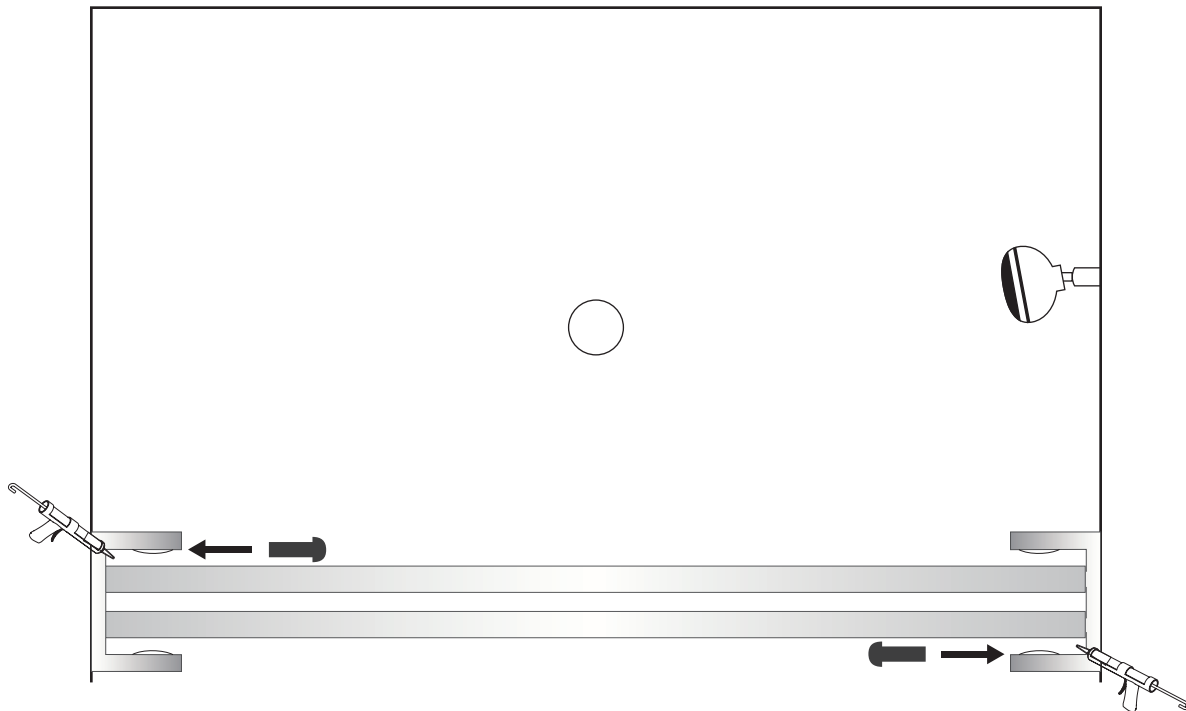

DO NOT OPERATE DOORS WITHOUT SAFETY BUMPERS AND SEALS PROPERLY INSTALLED

◆ Seal Page

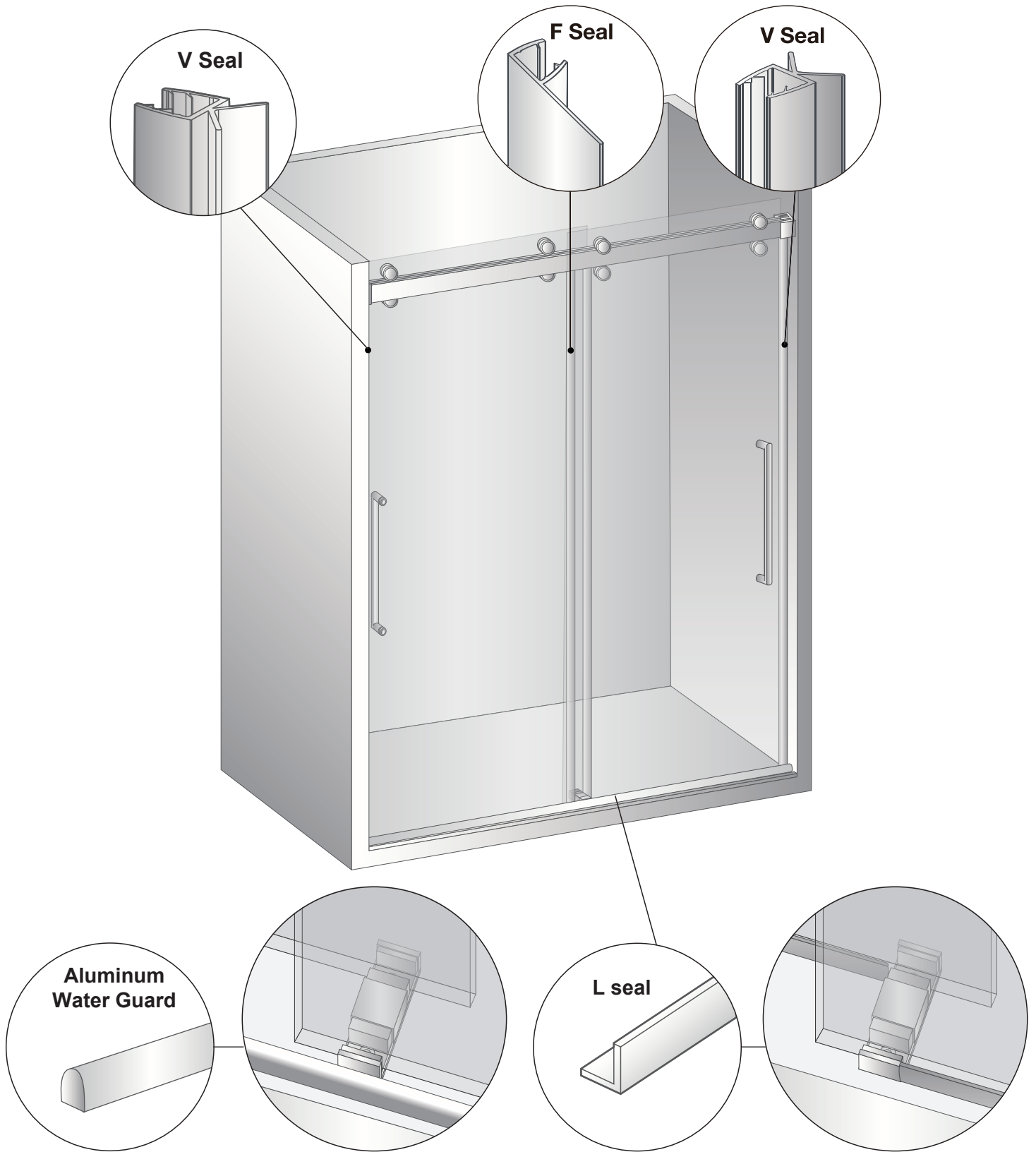

Preferred method: aluminum water guard

Optional method: polycarbonate L-seal

DO NOT OPERATE DOORS WITHOUT SAFETY BUMPERS AND SEALS PROPERLY INSTALLED