

eurotech

LUXURY SHOWER DOORS

BRIGHTON

TWINGLIDE FRAMELESS DUAL SLIDING SHOWER DOOR



Eurotech Showers

23532 Commerce Center Dr
Building B
Laguna Hills, CA 92653
949-716-4099
eurotechshowers.com

SUPER EASY INSTALL



eurotech
LUXURY SHOWER DOORS



HARDWARE FITS UP TO 60" WIDE OPENING

Tools Required

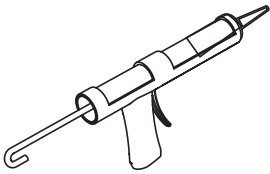

Silicone

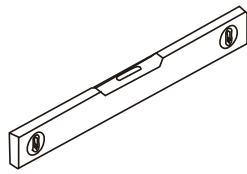

Level

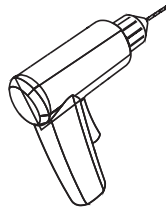

Drill

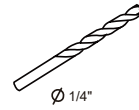

Masonry Bit

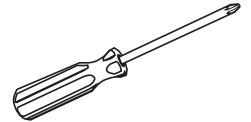

Screwdriver
(Phillips)

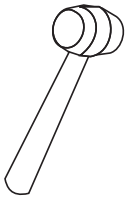

Mallet



Pencil

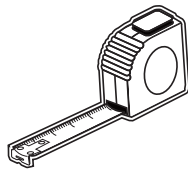

Tape Measurer

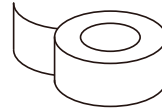

Painters
Tape

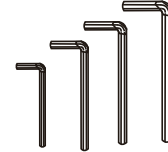

Allen Wrenches
(included)

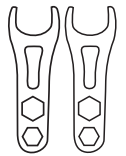

Wrenches
(included)



This product is heavy and may require two people to install.

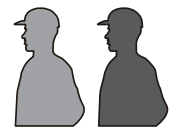

Congratulations on your purchase of your Eurotech Shower door, making your shower dreams come to life.

◆ Assembly Drawing

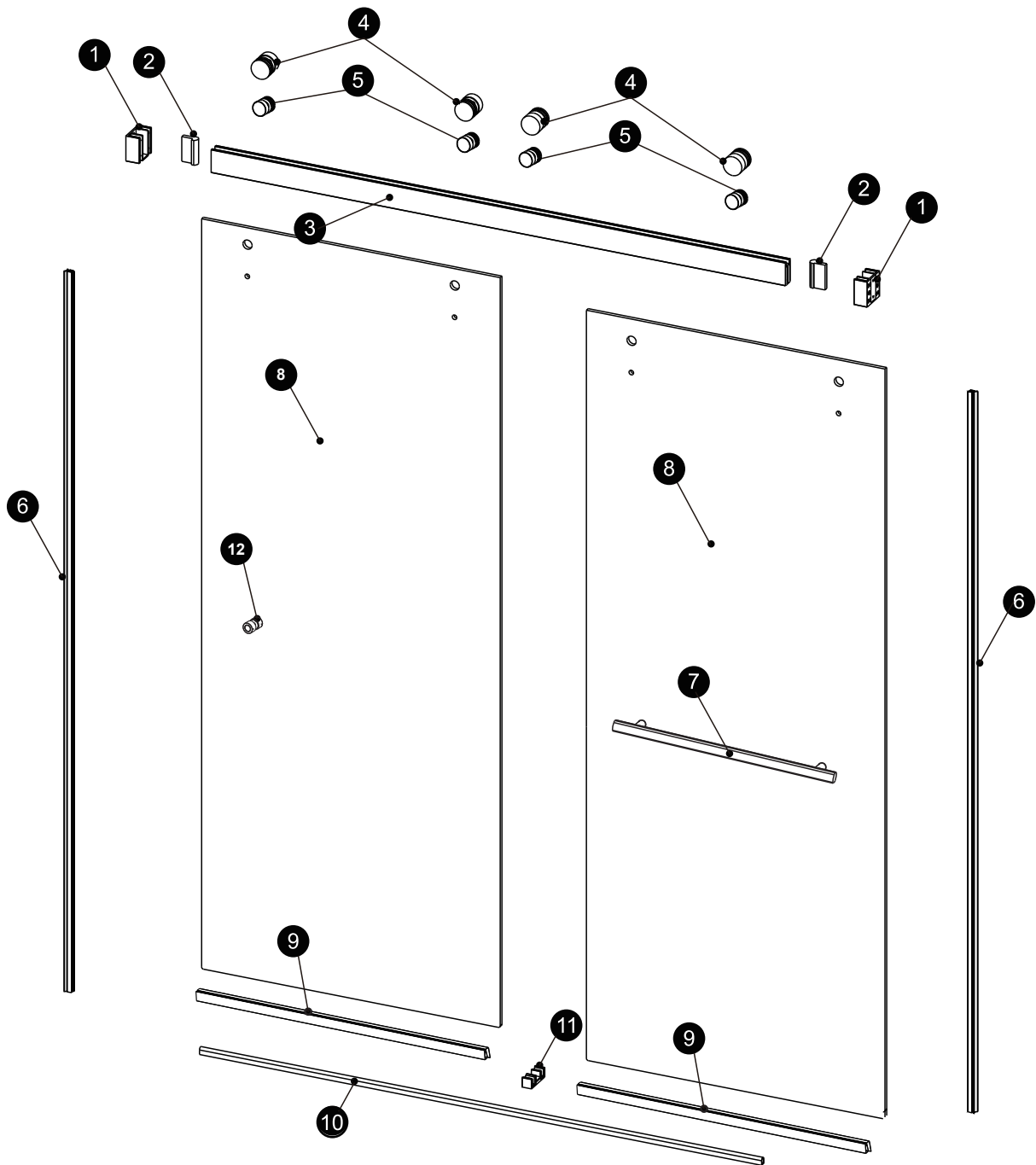

PACKING LIST

PART #	DESCRIPTION	Q'TY	PART #	DESCRIPTION	Q'TY
1	Wall Bracket	2pcs	7	Towel Bar	1pc
2	Safety Bumper	2pcs	8	Door Panel	2pcs
3	Track	1pc	9	Sweep seal	2pcs
4	Roller	4pcs	10	Aluminium Water Guard	1pc
5	Anti-Lift Pins	4pcs	11	Glass Guide	1pc
6	Bulb/V seal	2pcs	12	Knob	1pc

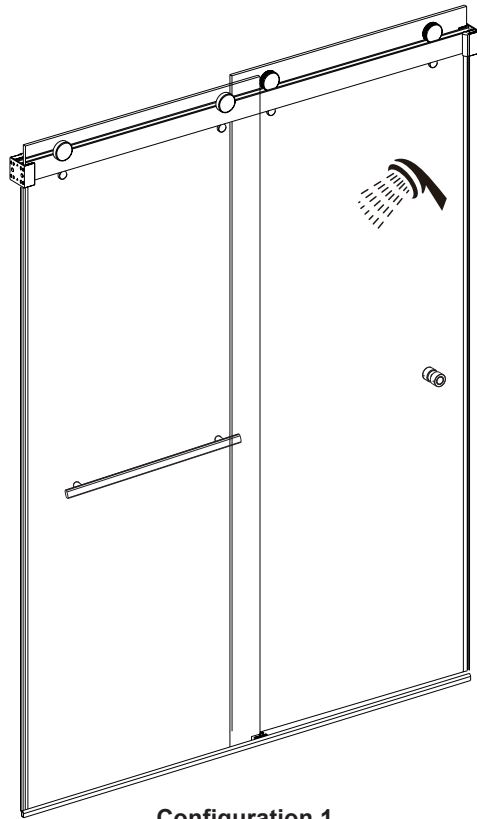

Configuration 1

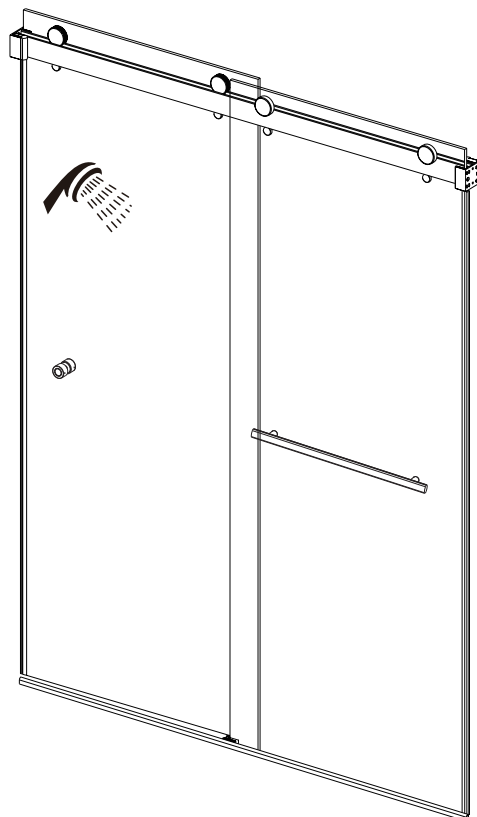

Configuration 2



(This Configurations is illustrated in this Manual)

Bar Installation: Mount wall bracket on **high side** first. Level bar to mark opposite wall for second wall bracket.

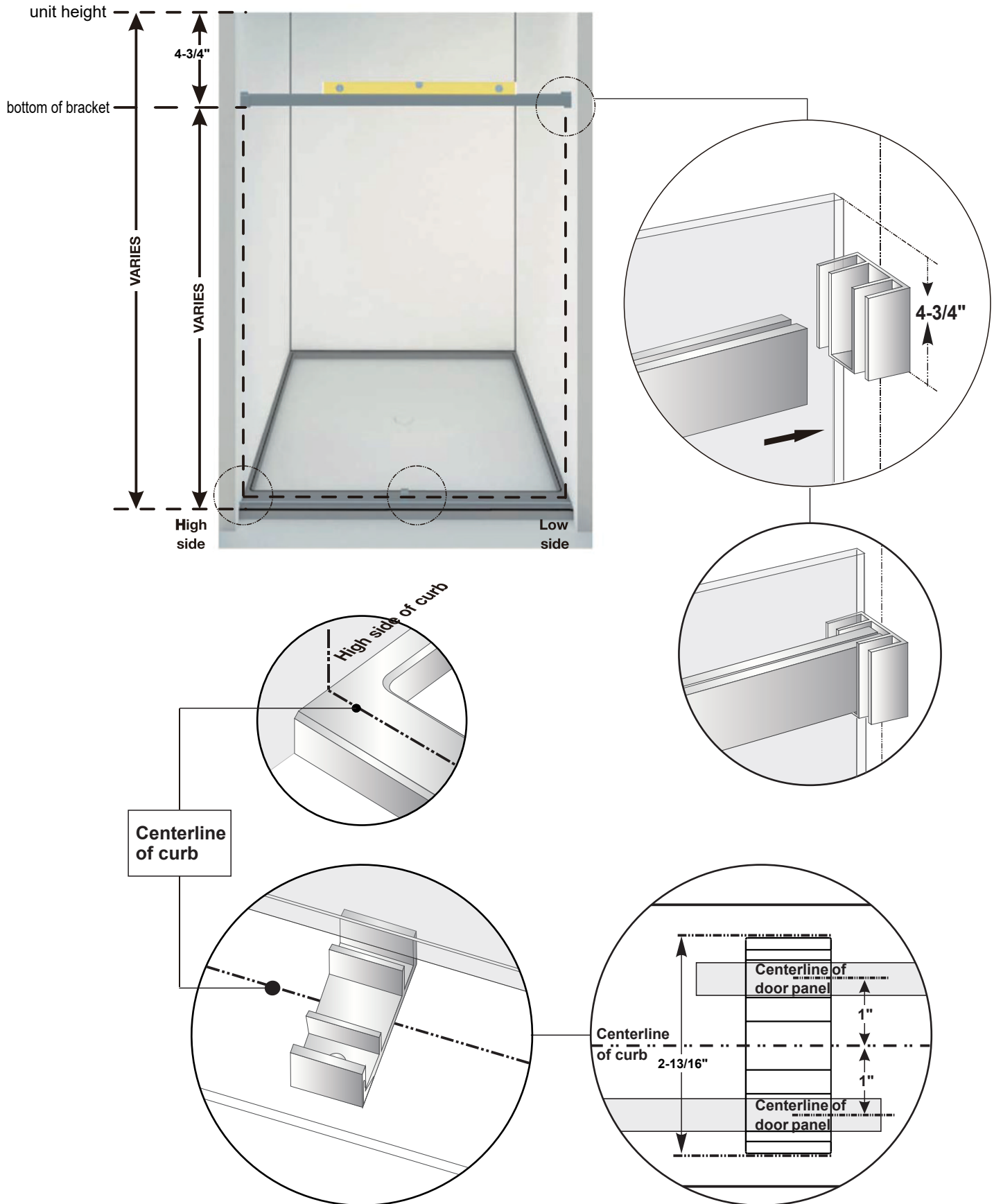

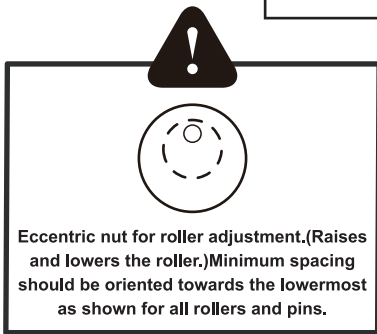
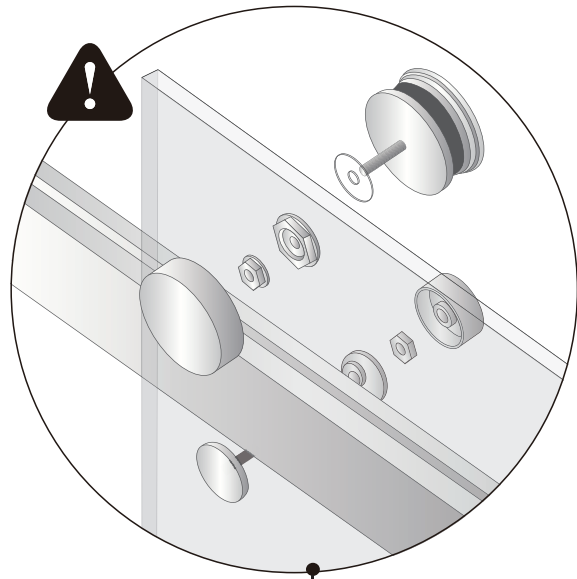
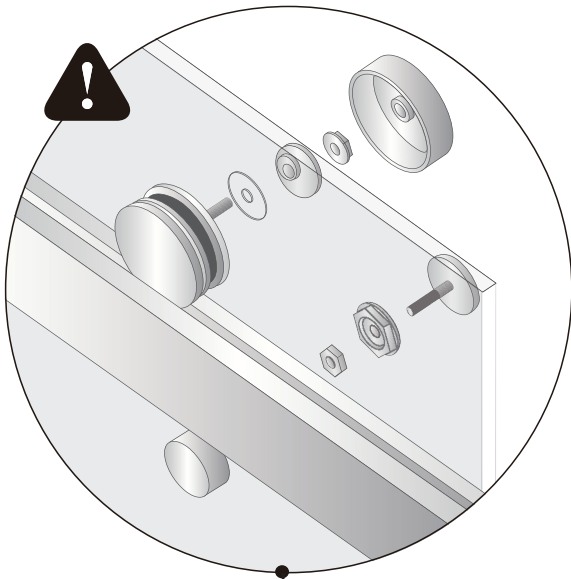

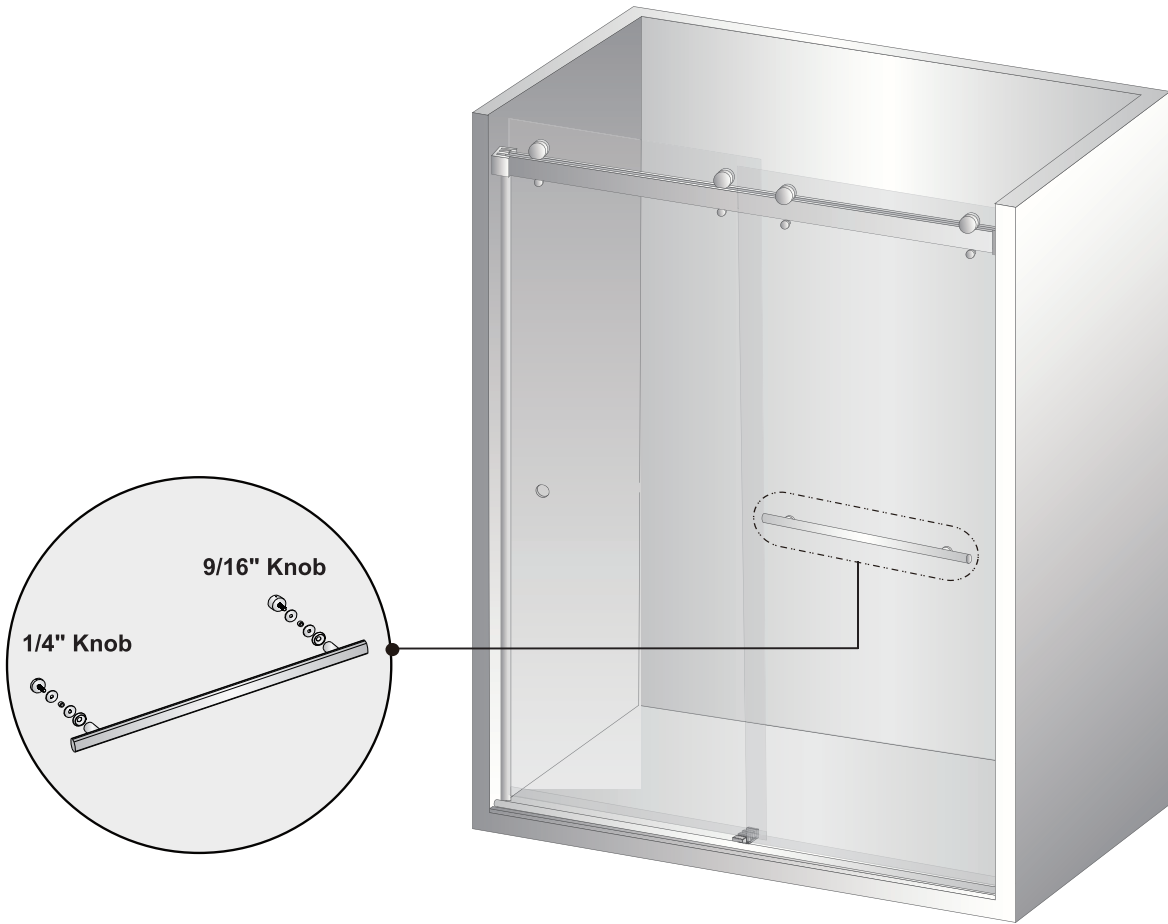

◆ Safety Bumper Page

For configurations with shower head to the left insert safety bumpers into wall brackets as shown

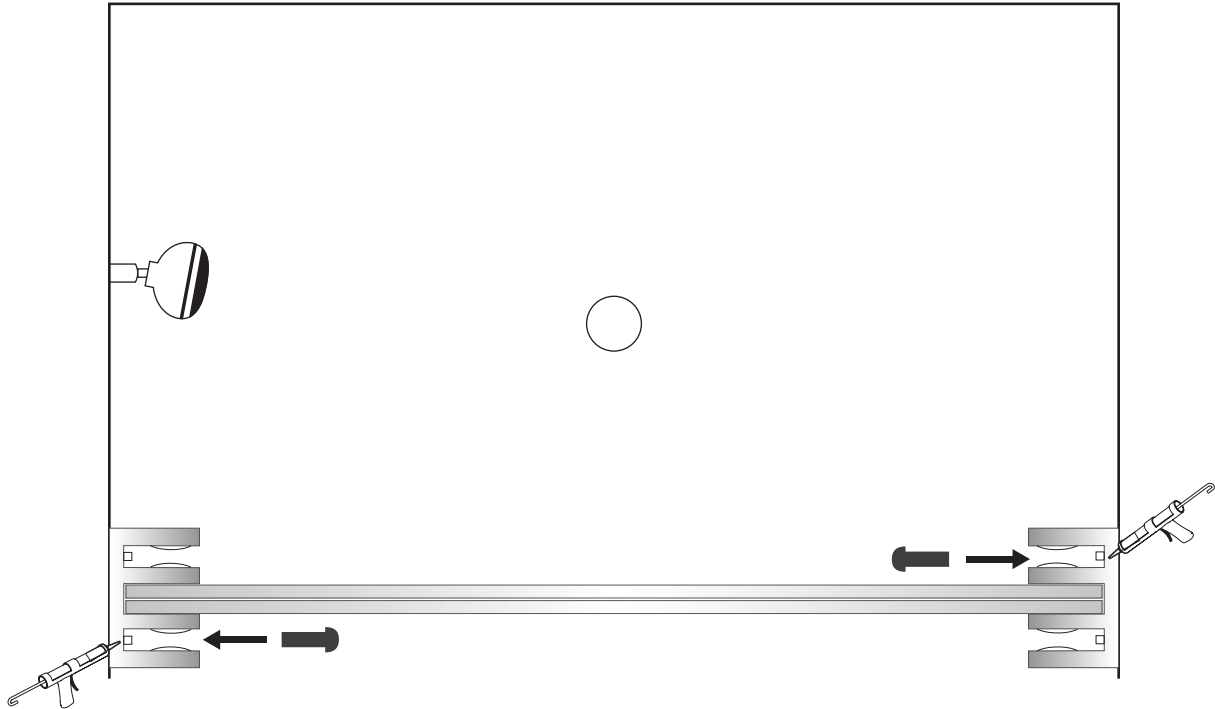

For configurations with shower head to the right insert safety bumpers into wall brackets as shown

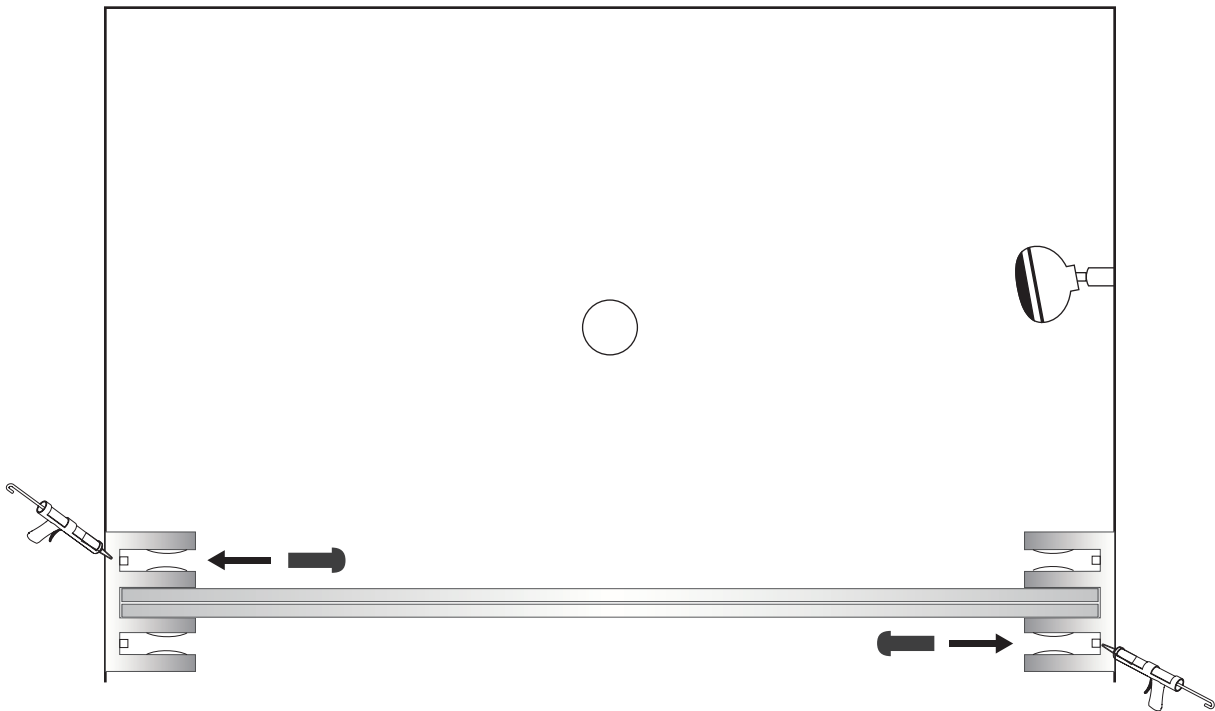

DO NOT OPERATE DOORS WITHOUT SAFETY BUMPER AND SEALS PROPERLY INSTALLED



DO NOT OPERATE DOORS WITHOUT SAFETY BUMPERS AND SEALS PROPERLY INSTALLED